



IP Office Essential Edition

PARTNER Version Quick Installation Guide

Notices

While reasonable efforts have been made to ensure that the information in this document is complete and accurate at the time of printing, Avaya assumes no liability for any errors. Avaya reserves the right to make changes and corrections to the information in this document without the obligation to notify any person or organization of such changes.

Documentation disclaimer

Avaya shall not be responsible for any modifications, additions, or deletions to the original published version of this documentation unless such modifications, additions, or deletions were performed by Avaya.

End User agree to indemnify and hold harmless Avaya, Avaya's agents, servants and employees against all claims, lawsuits, demands and judgments arising out of, or in connection with, subsequent modifications, additions or deletions to this documentation, to the extent made by End User.

Link disclaimer

Avaya is not responsible for the contents or reliability of any linked Web sites referenced within this site or documentation(s) provided by Avaya. Avaya is not responsible for the accuracy of any information, statement or content provided on these sites and does not necessarily endorse the products, services, or information described or offered within them. Avaya does not guarantee that these links will work all the time and has no control over the availability of the linked pages.

Warranty

Avaya provides a limited warranty on this product. Refer to your sales agreement to establish the terms of the limited warranty. In addition, Avaya's standard warranty language, as well as information regarding support for this product, while under warranty, is available to Avaya customers and other parties through the Avaya Support Web site: <http://www.avaya.com/support>. Please note that if you acquired the product from an authorized Avaya reseller outside of the United States and Canada, the warranty is provided to you by said Avaya reseller and not by Avaya.

Licenses

THE SOFTWARE LICENSE TERMS AVAILABLE ON THE AVAYA WEBSITE, [HTTP://SUPPORT.AVAYA.COM/LICENSEINFO/](http://support.avaya.com/licenseinfo/) ARE APPLICABLE TO ANYONE WHO DOWNLOADS, USES AND/OR INSTALLS AVAYA SOFTWARE, PURCHASED FROM AVAYA INC., ANY AVAYA AFFILIATE, OR AN AUTHORIZED AVAYA RESELLER (AS APPLICABLE) UNDER A COMMERCIAL AGREEMENT WITH AVAYA OR AN AUTHORIZED AVAYA RESELLER. UNLESS OTHERWISE AGREED TO BY AVAYA IN WRITING, AVAYA DOES NOT EXTEND THIS LICENSE IF THE SOFTWARE WAS OBTAINED FROM ANYONE OTHER THAN AVAYA, AN AVAYA AFFILIATE OR AN AVAYA AUTHORIZED RESELLER, AND AVAYA RESERVES THE RIGHT TO TAKE LEGAL ACTION AGAINST YOU AND ANYONE ELSE USING OR SELLING THE SOFTWARE WITHOUT A LICENSE. BY INSTALLING, DOWNLOADING OR USING THE SOFTWARE, OR AUTHORIZING OTHERS TO DO SO, YOU, ON BEHALF OF YOURSELF AND THE ENTITY FOR WHOM YOU ARE INSTALLING, DOWNLOADING OR USING THE SOFTWARE (HEREINAFTER REFERRED TO INTERCHANGEABLY AS "YOU" AND "END USER"), AGREE TO THESE TERMS AND CONDITIONS AND CREATE A BINDING CONTRACT BETWEEN YOU AND AVAYA INC. OR THE APPLICABLE AVAYA AFFILIATE ("AVAYA").

Avaya grants End User a license within the scope of the license types described below. The applicable number of licenses and units of capacity for which the license is granted will be one (1), unless a different number of licenses or units of capacity is specified in the Documentation or other materials available to End User. "Designated Processor" means a single stand-alone computing device. "Server" means a Designated Processor that hosts a software application to be accessed by multiple users. "Software" means the computer programs in object code, originally licensed by Avaya and ultimately utilized by End User, whether as stand-alone products or pre-installed on Hardware. "Hardware" means the standard hardware originally sold by Avaya and ultimately utilized by End User.

License types

Designated System(s) License (DS). End User may install and use each copy of the Software on only one Designated Processor, unless a different number of Designated Processors is indicated in the Documentation or other materials available to End User. Avaya may require the Designated Processor(s) to be identified by type, serial number, feature key, location or other specific designation, or to be provided by End User to Avaya through electronic means established by Avaya specifically for this purpose.

Copyright

Except where expressly stated otherwise, no use should be made of materials on this site, the Documentation(s) and Product(s) provided by Avaya. All content on this site, the documentation(s) and the product(s) provided by Avaya including the selection, arrangement and design of the content is owned either by Avaya or its licensors and is protected by copyright and other intellectual property laws including the sui generis rights relating to the protection of databases. You may not modify, copy, reproduce, republish, upload, post, transmit or distribute in any way any content, in whole or in part, including any code and software. Unauthorized reproduction, transmission, dissemination, storage, and or use without the express written consent of Avaya can be a criminal, as well as a civil, offense under the applicable law.

Third Party Components

Certain software programs or portions thereof included in the Product may contain software distributed under third party agreements ("Third Party Components"), which may contain terms that expand or limit rights to use certain portions of the Product ("Third Party Terms"). Information regarding distributed Linux OS source code (for those Products that have distributed the Linux OS source code), and identifying the copyright holders of the Third Party Components and the Third Party Terms that apply to them is available on the Avaya Support Web site: <http://support.avaya.com/Copyright>.

Preventing toll fraud

"Toll fraud" is the unauthorized use of your telecommunications system by an unauthorized party (for example, a person who is not a corporate employee, agent, subcontractor, or is not working on your company's behalf). Be aware that there can be a risk of toll fraud associated with your system and that, if toll fraud occurs, it can result in substantial additional charges for your telecommunications services.

Avaya fraud intervention

If you suspect that you are being victimized by toll fraud and you need technical assistance or support, call Technical Service Center Toll Fraud Intervention Hotline at +1-800-643-2353 for the United States and Canada. For additional support telephone numbers, see the Avaya Support Web site: <http://support.avaya.com>. Suspected security vulnerabilities with Avaya products should be reported to Avaya by sending mail to: securityalerts@avaya.com.

Trademarks

Avaya and Aura are trademarks of Avaya, Inc. The trademarks, logos and service marks ("Marks") displayed in this site, the documentation(s) and product(s) provided by Avaya are the registered or unregistered Marks of Avaya, its affiliates, or other third parties. Users are not permitted to use such Marks without prior written consent from Avaya or such third party which may own the Mark. Nothing contained in this site, the documentation(s) and product(s) should be construed as granting, by implication, estoppel, or otherwise, any license or right in and to the Marks without the express written permission of Avaya or the applicable third party. Avaya is a registered trademark of Avaya Inc. All non-Avaya trademarks are the property of their respective owners.

Downloading documents

For the most current versions of documentation, see the Avaya Support Web site: <http://www.avaya.com/support>

Contact Avaya Support

Avaya provides a telephone number for you to use to report problems or to ask questions about your product. The support telephone number is 1-800-242-2121 in the United States. For additional support telephone numbers, see the Avaya Web site: <http://www.avaya.com/support>

Contents

1. Introduction

1.1 System Components.....	8
1.2 Environmental Requirements.....	9
1.3 Space Requirements.....	10
1.3.1 Free Standing.....	10
1.3.2 Wall Mounting.....	11
1.4 Cabling and Cables.....	12
1.5 Phones Supported.....	13
1.6 System Capacity/Planning Rules.....	14

2. Installation

2.1 Unpacking.....	17
2.2 IP500 Card Installation.....	18
2.2.1 IP500 Daughter Card Preparation.....	18
2.2.2 IP500 Card Insertion.....	19
2.3 Starting the System.....	20
2.4 Connecting the System.....	21
2.5 Set the System Password.....	22
2.6 Change the Admin Password.....	23
Index	25

Chapter 1.

Introduction

1. Introduction

IP Office Essential Edition - PARTNER® Version runs on the Avaya IP Office 500 V2 hardware platform. This quick installation manual covers 'out of the box' installation of the system with analog trunks only. When this quick installation is completed, such a system can be used to make and receive calls with no further programming or setup required.

This guide does not cover installations using the features listed below. They are covered by the *IP Office Essential Edition - PARTNER® Version Installation and Reference Guide*.

- External Expansion Modules.
- Rack Mounting.
- Out of Building Extensions
- SIP Trunks
- PRI/T1 Trunks
- Advanced configuration using IP Office Manager.
- No LAN network connection.

Additional Manuals



The following additional manuals are available:

- *IP Office Essential Edition - PARTNER® Version Phone Based Administration Manual*
Covers the range of system programming that can be performed from extensions 10 and 11 when fitted with 1400 Series phone (1408 and 1416) and ETR phone (ETR18D and ETR34D) extensions
- *IP Office Essential Edition - PARTNER® Version Phone User Guide*
Cover actions, including personal programming, that users can do from 1400 Series phone (1408 and 1416) and ETR phone (ETR18D and ETR34D) extensions.
- *IP Office Essential Edition - PARTNER® Version Manager*
Cover the system programming that can be performed using the IP Office Manager application.
- *IP Office Essential Edition - PARTNER® Version Installation Manual*
Covers installation including non-analog trunks, external expansion modules, rack mounting and other options not covered in this manual.

1.1 System Components

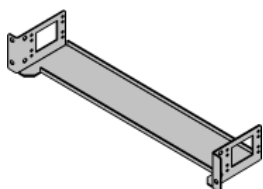
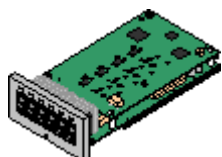
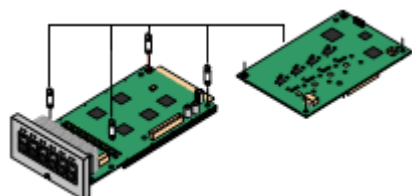
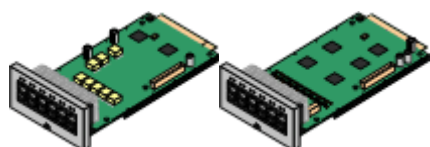
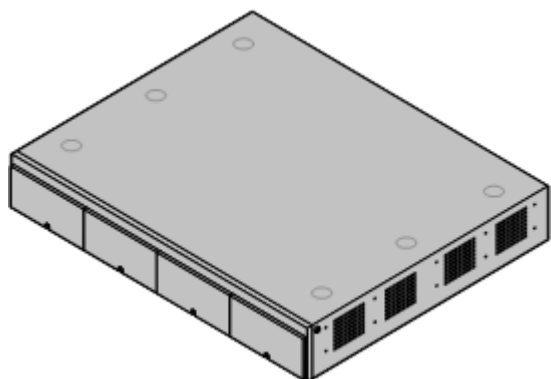
The following are the components of an IP Office Essential Edition - PARTNER® Version system covered by this quick installation guide.



- IP Office IP500 V2 Control Unit
The control unit holds the main configuration and performs the routing and switching for telephone calls and data traffic. The control unit includes 4 slots for optional base cards to support trunk and phone extension ports.
-  Avaya System SD Card
This card is used to hold system files and provide voicemail. The card has a unique serial number which is used to validate license keys entered into the system's configuration. The card is mandatory for correct system operation.
- The control unit is not supplied with a power cord. An IEC60320 C13 type earthed power cord is required.
- IP500 Base Cards
The IP500 control unit has slots for up to 4 IP500 base cards. These can be used to add analog extension port, digital extension ports, voice compression channels and some legacy IP400 cards.
 - IP500 Digital Station 8 Base Card (*Maximum 3*)
Each card supports up to 8 1400 series phones.
 - IP500 Analog Phone 8/Phone 2 Base Cards (*Maximum 4*)
Each card supports 8 or 2 analog phones.
 - IP500 ETR6 Base Card (*Maximum 3*)
Each card supports up to 6 ETR phones (only 2 ETR34 or ETR34D phones).
- IP500 Trunk Daughter Cards
The IP500 base cards can be fitted with an IP500 trunk daughter card in order to support trunk connections.
 - IP500 Analog Trunk Card (*Maximum 4*)
This card provides 4 analog trunk connections.
 - IP500 PRI Trunk Card (*Maximum 1*)
This card provides a single PRI/T1 trunk connection.
- IP500 ATM Combination Cards (*Maximum 2*)
This card is a pre-paired base and daughter card. It provides 6 digital station ports, 2 analog phone ports, 10 VCM channels and 4 analog trunk ports. The trunk daughter card cannot be removed or replaced with another type.
- [Cables](#) 
The IP Office is designed primarily for connection to a structured cabling system using CAT3 UTP cabling. This approach allows telephone and data traffic to share the same wiring infrastructure and simplifies equipment moves.
- Wall Mounting Kit
The control unit can be used free-standing, with an external expansion modules stacked above it. Alternatively the control unit can be wall mounted though no external expansion module is supported when wall mounted.
- Phones
The following phones are supported on IP Office Essential Edition - PARTNER® Version systems:
 - ACS "Refreshed" Series: ETR6D, ETR18D, ETR34D, 3910 and 3920.
 - ACS "Euro" Series: ETR6, ETR18, ETR18D, ETR34D.
 - 1400 Series: 1403, 1403SW, 1408, 1416.
 - Analog Phones

1.2 Environmental Requirements

The planned location must meet the following requirements. If being installed into a rack system, these are requirements for within the rack:

1. Temperature: 0°C to 40°C / 32°F to 104°F.
2. Humidity: 10% to 95% non-condensing.
3. Check there are no flammable materials in the area.
4. Check there is no possibility of flooding.
5. Check that no other machinery or equipment needs to be moved first.
6. Check that it is not an excessively dusty atmosphere.
7. Check that the area is unlikely to suffer rapid changes in temperature and humidity.
8. Check for the proximity of strong magnetic fields, sources of radio frequency and other electrical interference.
9. Check there are no corrosive chemicals or gasses.
10. Check there is no excessive vibration or potential of excessive vibration, especially of any mounting surface.
11. Check that where telephones are installed in another building, that the appropriate protectors and protective grounds are fitted.
12. Check there is suitable lighting for installation, system programming and future maintenance.
13. Check that there is sufficient working space for installation and future maintenance.
14. Ensure that likely activities near the system will not cause any problems, e.g. access to and maintenance of any other equipment in the area.
15. Where ventilation holes are present on any of the IP Office units, those holes should not be covered or blocked.
16. The surface must be flat horizontal for free-standing installations.

Wall Mounting

In addition to the requirements above, the following are applicable to IP Office units that support wall mounting.

1. Units must only be mounted onto permanent wall surfaces.
2. The surface must be vertical and flat.
3. Orientation of the unit must be as shown in the section on IP500 Wall Mounting.
4. The appropriate Avaya wall mounting kits must be used.

IMPORTANT SAFETY INSTRUCTIONS

When using your telephone equipment, basic safety precautions should always be followed to reduce the risk of fire, electric shock and injury to persons, including the following:

1. Do not use this product near water, for example, near a bath tub, wash bowl, kitchen sink or laundry tub, in a wet basement or near a swimming pool.
2. Avoid using a telephone (other than a cordless type) during an electrical storm. There may be a remote risk of electric shock from lightning.
3. Do not use the telephone to report a gas leak in the vicinity of the leak.
4. Use only the power cord and batteries indicated in this manual.

1.3 Space Requirements

IP Office control units and external expansion modules are designed to be installed either in a free-standing stack or into a 19" rack system. Rack installation requires a rack mounting kit for the control unit and each expansion module.

If being used without any external expansion modules, the control unit can be wall mounted using a wall mounting kit.

- **Cable Clearance**
Clearance must be provided at the front and rear of all modules for cable access. Allow a minimum clearance of 90mm (3.5 inches).
- **Additional Clearance**
Care should be taken to ensure that the positioning of the modules does not interrupt air flow and other factors that may affect [environmental requirements](#)^{9b}. This is especially important on control units which have ventilation slots at the side.
- **Cable Access**
Power cords must not be attached to the building surface or run through walls, ceilings, floors and similar openings. Installation measures must be taken to prevent physical damage to the power supply cord, including proper routing of the power supply cord and provision of a socket outlet near the fixed equipment or positioning of the equipment near a socket outlet.

1.3.1 Free Standing

The ventilation slots on the rear and sides should not be covered or blocked.

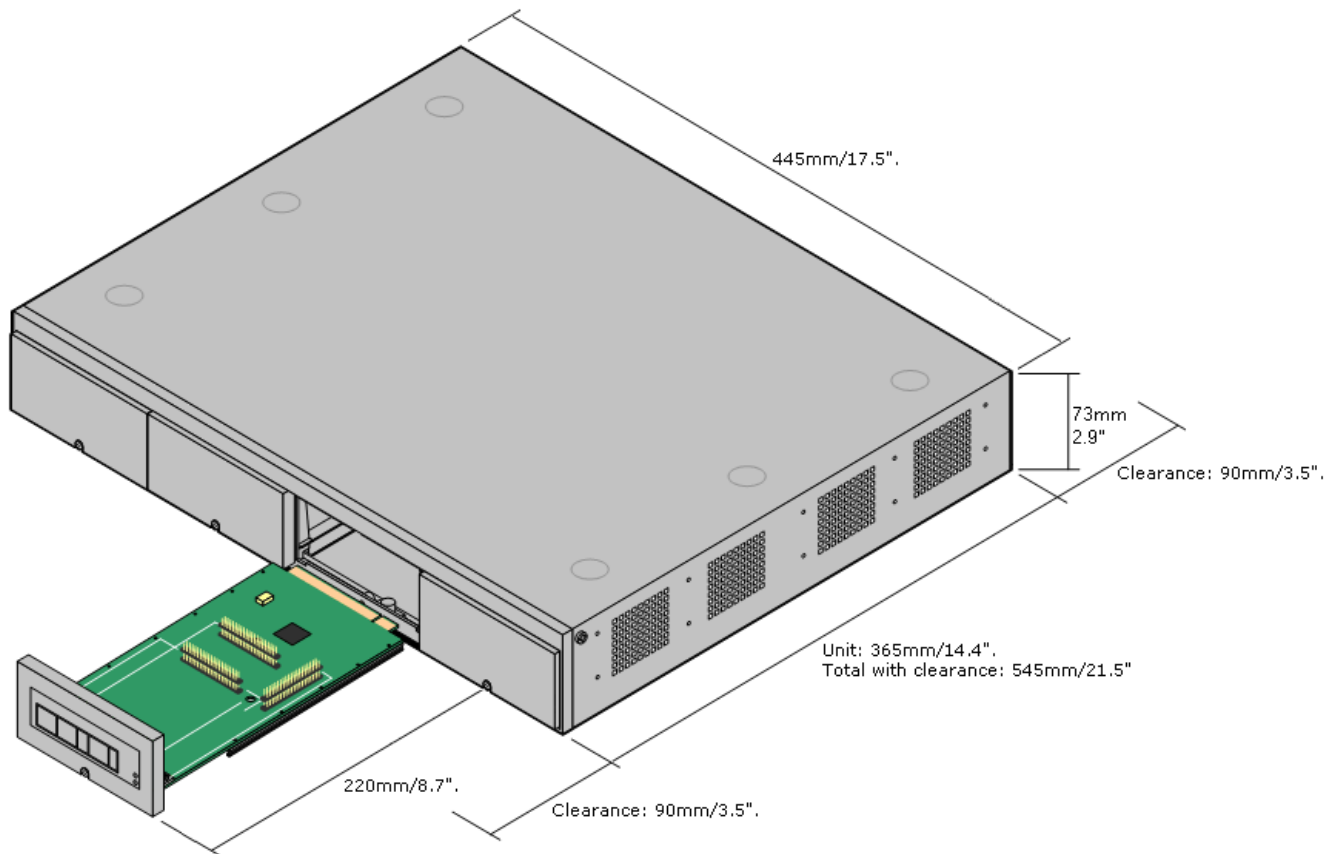

1.3.2 Wall Mounting

The control unit can be wall mounted if not using any external expansion modules. An IP500 wall mounting kit is required in addition to suitable wall fixings.

- IP500 Wall Mounting Kit (*SAP Code 700430150*)

Additional 4.5mm fixings suitable for the wall type are required. A clearance of 500mm around the control unit is required.

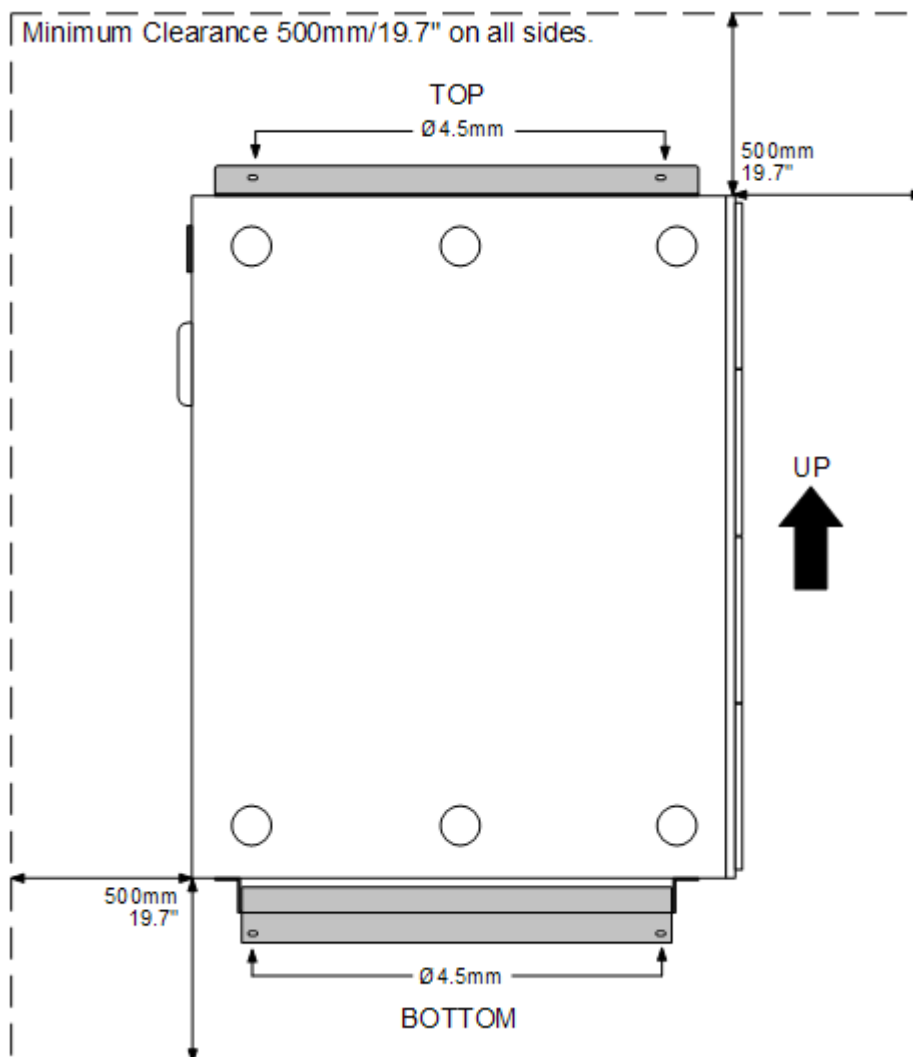
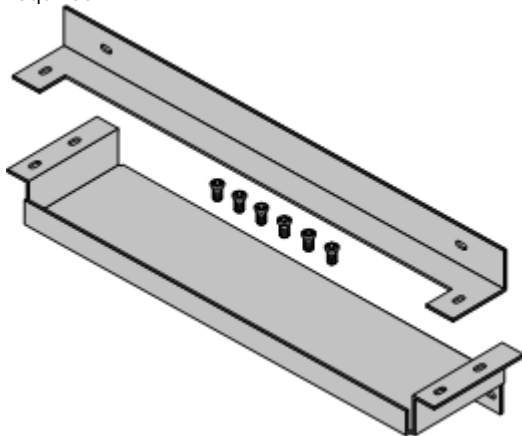

1.4 Cabling and Cables

The system is designed primarily for use within an RJ45 structured cabling system using CAT3 unshielded twisted-pair (UTP) cabling and RJ45 sockets.

A structured cabling system is one where cables are run from a central RJ45 patch panel in the communications/data room to individual RJ45 sockets at user's desk. All wires in each cable between the patch panel and the desk socket are connected straight through. This arrangement allows devices connected at the patch panel to be swapped to match the type of device that needs to be connected at the user socket. For example, making one user socket a phone port and another user socket a computer LAN port, without requiring any rewiring of the cables in between.

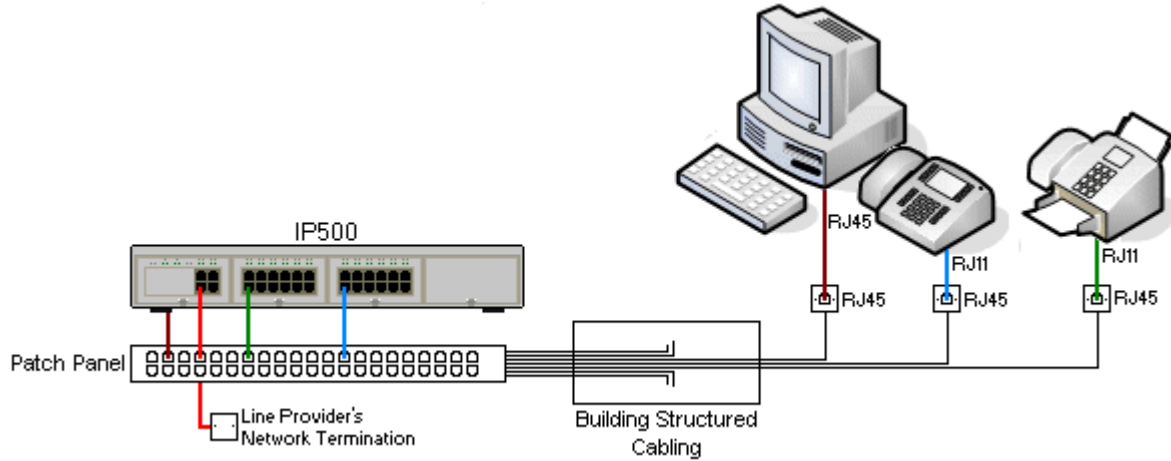

- **Traditional IDC Punchdown Wiring Installations**
Where necessary, the far end RJ45 plug can be stripped from IP Office cables and wired into traditional wiring systems using punch-block connectors. This type of installation should be performed by an experienced wiring technician.
- **Trunk Connections**
The majority of IP Office trunk ports use RJ45 connectors for acceptance of an RJ45-to-RJ45 cable. However, connection at the line providers end may require use of a different plug type in order to match the line providers equipment.
- **RJ11 Phone Connectors**
Many phones use RJ11 sockets and are supplied with RJ11-to-RJ11 cables. RJ11 plugs can be inserted into RJ45 sockets and in many case the connection will work. However this is not recommended or supported as the connection lock is not truly positive and may become disconnected. An RJ45-to-RJ11 cable should be used for these connections.

Standard IP Office Cables

The following are Avaya standard cables available for use with IP Office systems. The maximum length is applicable if the standard Avaya cable is replaced with an alternative cable.

Cable	Description	Part number	Standard Length	Maximum Length
9-Way DTE Cable	Connects to control unit RS232 DTE port. 9-Way D-type plug to 9-way D-type socket.	–	2m/6'6".	2m/6'6".
Structured Cabling DS Line Cable	Connects from RJ45 sockets to RJ11 socketed digital station and analog phones.	700047871	4m/13'2".	See table below.
PRI Trunk Cable	Connects PRI trunk ports to the line providers network termination point. RJ45 to RJ45. Red.	700213440	3m/9'10".	–
Expansion Interconnect Cable	Connects the control unit to expansion module. RJ45 to RJ45. Blue.	700213457	1m/3'3".	1m/3'3".
LAN Cable	Connects from IP Office LAN ports to IP devices. RJ45 to RJ45. Grey.	700213481	3m/9'10".	100m/328'.

The table below details the maximum total cable distances for DS and analog extensions using different cable types.

Telephone	Unshielded Twisted-Pair (UTP) - 50nf/Km			CW1308
	AWG22 (0.65mm)	AWG24 (0.5mm)	AWG26 (0.4mm)	
1400 Series	1000m/3280'.	1000m/3280'.	400m/1310'.	400m/1310'.
ETR	1000m/3280'.	1000m/3280'.	400m/1310'.	–
Analog Phones	1000m/3280'.	1000m/ 3280'.	400m/1640'.	800m/2620'.

1.5 Phones Supported

The following phones are supported on IP Office Essential Edition - PARTNER® Version systems:

- ACS "Refreshed" Series: ETR6D, ETR18D, ETR34D, 3910 and 3920.
- ACS "Euro" Series: ETR6, ETR18, ETR18D, ETR34D.
- 1400 Series: 1403, 1403SW, 1408, 1416.
- Analog Phones: Any analog phones to be used with the system should be tested and validated by the installer before use.

Notes

1. ETR34 phones are limited to 2 per IP500 ETR6 base card and a maximum of 4 per system.
2. The ETR phones support attachment of an additional analog phone via the ETR phones Aux socket. Such analog phones operate with the same extension number as the ETR extension to which they are attached.
3. The 1416 can be used with DBM32 button modules to provide additional programmable buttons. Up to 3 DBM32 button modules can be attached to a 1416.
4. The 3910 and 3920 are single handset DECT systems. The handset base station attaches to an analog port.

1.6 System Capacity/Planning Rules

Maximum Component Capacities

Component	Maximum	Description
IP500 Base Cards	4	
IP500 Phone 8 Base Card	4	Provides ports for 8 analog phone extension.
IP500 Phone 2 Base Card	4	Provides ports for 2 analog phone extensions.
IP500 Digital Station 8 Base Card	3	Provides ports for 8 1400 Series phone extensions.
IP500 ETR6 Base Card	3	Provides ports for 6 ETR phone extensions.
IP500 ATM Combination Card	2	Provides ports for 6 1400 Series phone extensions and 4 analog trunks.
IP Office 500 Daughter Cards	4	
IP500 Analog Trunk Daughter Card	3	Supports 4 analog trunks.
IP500 PRI 1 Trunk Daughter Card	1	Supports a single PRI/T1 trunk connection.
IP Office 500 External Expansion Modules	1	
IP500 Phone 16	1	Provides ports for 16 analog phone extensions.
IP500 Digital Station 16	1	Provides ports for 16 1400 Series phone extensions.

Maximum System Capacity

Extensions	Maximum	
	48	
1400 Series Phones	46	3 x DS8 Base Cards, 1 x ATM Combination Card and 1 x Digital Station 16 External Expansion Module.
ETR Phones	18	3 x ETR6 Base Cards.
Analog Phones	48	4 x Phone 8 Base Cards.
Trunks	56	
Analog Trunks	12	4 x IP500 ATM4 Trunk Daughter cards mounted on the IP500 base cards or 2 plus 2 x IP500 ATM Combination Cards.
T1 Channels	24	1 x IP500 PRI Trunk Daughter Card mounted on one of the IP500 base cards.
PRI Channels	23	
SIP Trunk Channels	20	Licensed.

Notes

While base cards can be installed in any slot and daughter cards added to any base card, the following should be considered when planning the installation.

- The first two extensions (extensions 10 and 11) provided by slot 1 of the control unit are used as system administrator extensions if a card providing digital station or ETR ports is fitted. If a card supporting only analog extension ports is fitted in the first slot, system administration can only be done using the IP Office Manager application.
- While the IP500 Analog Trunk Daughter card can be fitted to any IP500 base card, when fitted to an IP500 Phone 8 Base Card the combination provides additional power fail ports.

Chapter 2.

Installation

2. Installation

IP Office Equipment

- IP Office 500v2 control unit.
- Power lead for the control unit. This should be an IEC60320 C13 earthed power cord.

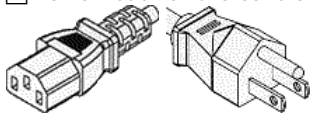

- Base and trunk daughter cards to fulfill customer system requirements
- Avaya SD Card registered to customer
- If system is being wall mounted, wall mounting kit and suitable fixings for the wall type.



Tools Required

- Flat screwdriver No 5 medium size.
- Cutter for cable ties.
- Wrist-strap for anti-static grounding or similar.
- Indelible marker for cable labeling.





Additional PartParts Required

- Cable ties.
- Cabling labels.
- Technical Bulletins
Each IP Office Essential Edition - PARTNER® Version software release is normally accompanied by a Technical Bulletin detailing special installation requirements, known issues, etc. Various software releases and their associated Technical Bulletins can also be obtained from <http://support.avaya.com>.

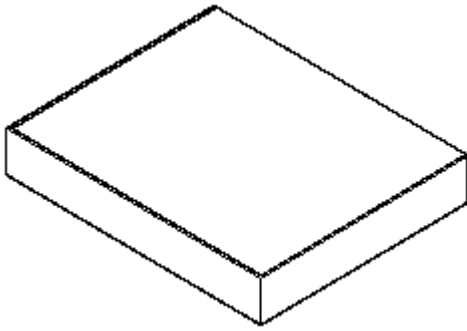
2.1 Unpacking



 Objective - To check that the correct equipment has been supplied and that no damage has occurred during transit.

 Information Required

- Equipment Checklist.
Obtain an installation checklist of the parts and equipment expected.

- Identify the Avaya SD Memory Card
The serial number is printed on the SD, prefixed with *FK*.



- Check for Package Damage.
Before unpacking any equipment, check for any signs of damage that may have occurred during transit. If any damage exists bring it to the attention of the carrier.
- Check the Correct Parts Have Been Delivered.
Check all cartons against the packing slip and ensure that you have the correct items. Report any errors or omissions to the equipment supplier.
- Retain All Packaging and Documentation.
While unpacking the equipment, retain all the packaging material. Fault returns are accepted only if repackaged in the original packaging. If performing a staged installation, the original packaging will also assist when repacking equipment to be moved to the final install site.
- Ensure that Anti-Static Protection Measures are Observed.
Ensure that anti-static protection measures are observed at all times when handling equipment with exposed electrical circuit boards.
- Check All Parts.
Visually inspect each item and check that all the necessary documentation and accessory items have been included. Report any errors or omissions to the dealer that supplied the equipment.
- Check All Documentation.
Ensure that you read and retain any documentation included with the equipment.

2.2 IP500 Card Installation

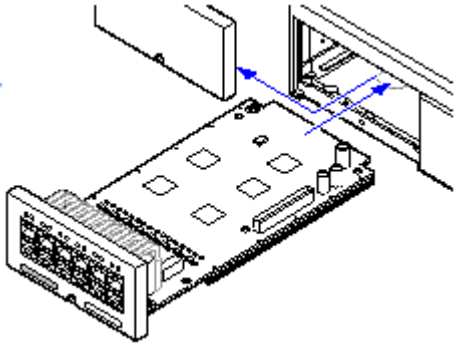

The IP500 base cards and trunk daughter cards should be fitted before power is applied to the control unit. Ensure that cards are inserted in the order that matches the planned or pre-built configuration.

1. [Fitting IP500 Trunk Daughter Cards to the Base Cards.](#) ^[18]
2. [Installing IP500 Cards into the Control Unit.](#) ^[19]

Refer to [System Capacity/Planning Rules](#) ^[14] for any recommendations and restrictions on where particular cards can be installed.

- Correct anti-static protection steps should be taken before handling circuit boards.
- Cards must never be added or removed from the control unit while it is switched on.

2.2.1 IP500 Daughter Card Preparation

IP500 trunk daughter cards can be fitted to any IP500 base card. For IP500 Combination cards, the trunk daughter card is pre-installed and cannot be changed.

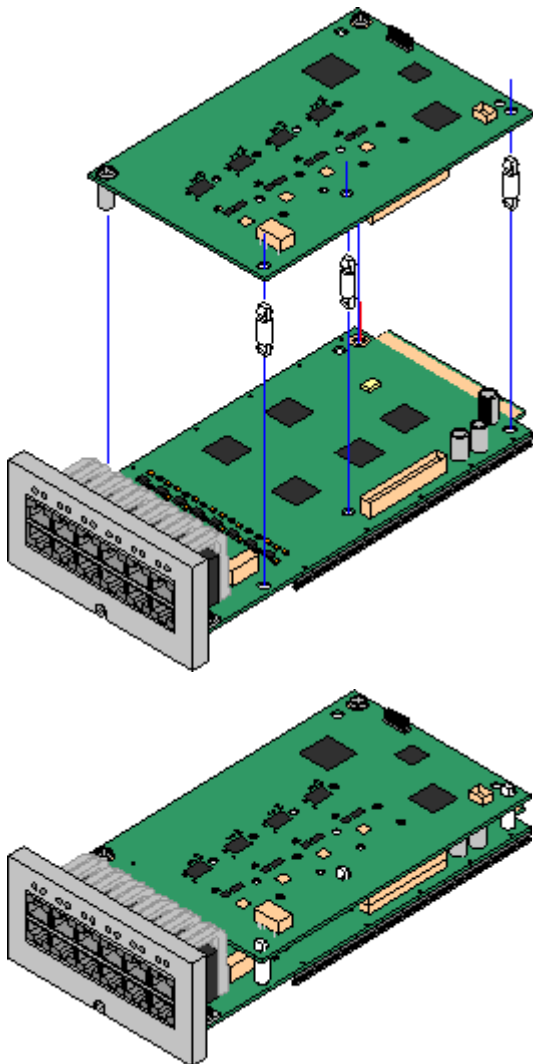

- Correct anti-static protection steps should be taken while handling circuit boards.

Parts and Equipment Required

1. IP500 Base Card
2. IP500 Trunk Daughter Card
3. 3 Stand Off Pillars
These are supplied with the trunk daughter card.

Tools Required.

1. 5mm Flat-blade screwdriver.
2. Anti-static wrist strap and ground point.

Procedure: Installing an IP500 Trunk Daughter Card

1. Check that correct cards have been supplied.
2. Ensure that you are wearing an anti-static wrist strap connected to a suitable ground point.
3. On the base card identify the position of 3 holes for the plastic pillars for the IP500 card. These are along the same edge as the card connector.
4. Fit the stand off pillars to the IP500 base card.
5. If there is a clip-on metal shield over the connector block on the base card, remove it.
6. Using minimal force and checking that the pins are correctly located, push the IP500 trunk card onto its connector block and the stand off pillars.
7. Check that the card connector has snapped into position.
8. Using the washers and screws provided, secure the metal stand off pillars to the base card.
9. A set of labels are supplied with the trunk daughter card. Fit the appropriate label to the front of the base card.

2.2.2 IP500 Card Insertion

Having prepared each IP500 base card by adding any [trunk daughter card](#)¹⁸ if required, the base card can be inserted into the control unit.

-  Warnings
 - Correct anti-static protection steps should be taken while handling circuit boards.
 - Cards must never be added or removed from the control unit while it has power connected.

- Tools Required
 - 5mm Flat-blade screwdriver.
 - Anti-static wrist strap and ground point.

Installing an IP500 Card

1. Check that there is no power to the control unit.
2. Using a flat-bladed screwdriver, remove the cover from the slot on the front of the control unit that will be used for each card being installed. This cover is no longer required but should be retained until installation has been completed.

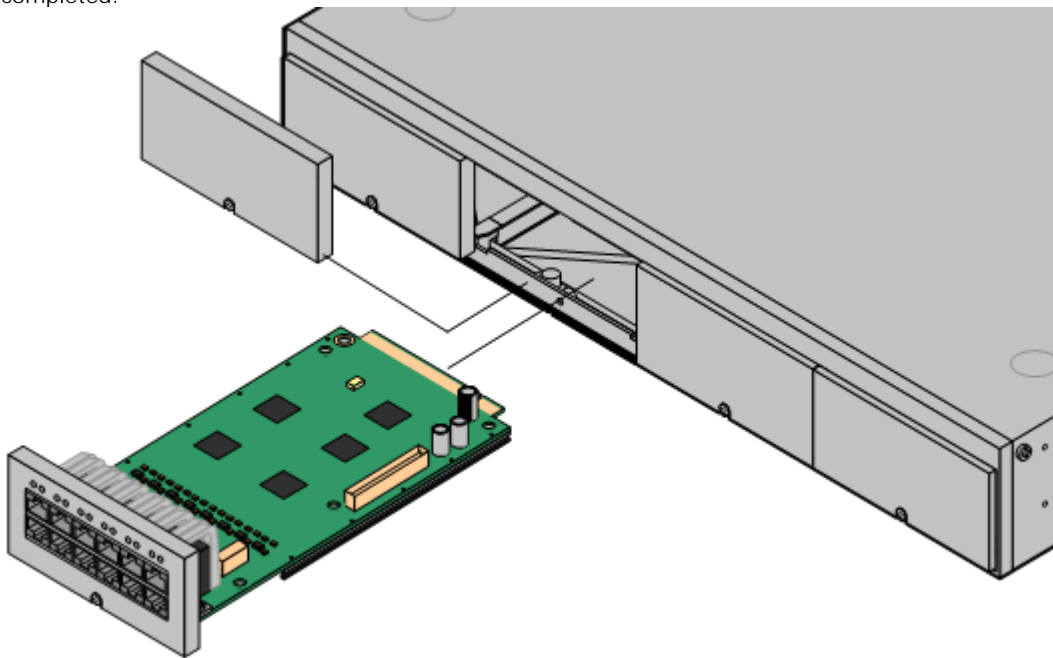

3. Allowing the card to rest against the bottom of the slot, begin sliding it into the control unit. When half inserted, check that the card rails have engaged with the slot edges by trying to gently rotate it. If the card rotates remove it and begin inserting it again.
4. The card should slide in freely until almost fully inserted. At this point apply pressure at the base of the front of the card to complete insertion.
5. Using a flat-bladed screwdriver secure the card.

2.3 Starting the System

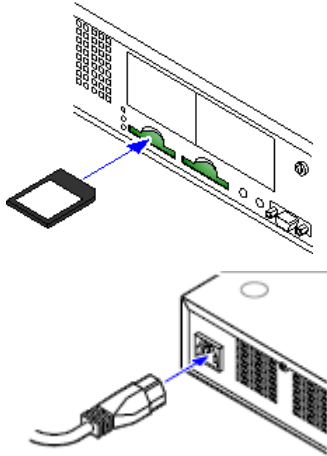

1. With the IP500 V2 control unit unpowered, insert the Avaya System SD card into the System SD slot on the rear of the control unit.
2. Apply power to the IP500 V2 control unit. The power outlet used must include a switch and the power outlet must have a protective earth connection.
3. The control unit will begin loading firmware from the System SD card with which it will upgrade itself and the components installed in the control unit.
4. This process takes approximately a minute. The end of this process will be indicated by LED1 on each base card flashing every 5 seconds. LED9 on each base card fitted with a trunk daughter card will also flash every 5 seconds.

The LEDs on the rear of the control unit go through the following sequence during a normal start up. Note that the times are approximately only:

LED	4s	4s	12s	5s	2s	5s	5s	10s	10s	Finished
CPU	Orange	Green	Green	Green Red	Green	Green	Green	Green	Green	Green
System SD	Orange	Off	Green	Green	Green	Off	Green	Green	Green Flash	Green
Optional SD If present.	Orange	Off	Green	Green	Green	Off	Off	Green	Green	Green

On the front of the control unit, LED1 on any IP500 base cards fitted is used as follows. LED9 is also used for any trunk daughter cards fitted.

LED	30s	30s	Finished
LED1/LED9	Red	Red Fast Flash	Red Flash every 5 seconds

2.4 Connecting the System

If the site already has a patch panel for all outside lines and extensions, you should be able to use the existing wiring to install the system hardware and connect telephones to the system yourself.

During control unit startup

- Extensions and Users

A user is automatically created for each physical extension port detected in the system. Users are assigned extension numbers upward from 10, starting from the first card slot. User names take the form Extn10, Extn11,

Installing Telephones

After you have installed the IP Office 500v2 control unit and have connected the line and extension cords and gone [live](#)²⁰, you are ready to install the telephones. Installing the telephones includes assembling, connecting and testing, the telephone. As desired, you also can connect an Intercom Autodialer to certain telephones.

Assembling PARTNER Telephones

All PARTNER telephones are shipped with a stand for either desk-mounting or wall-mounting the telephone. For other telephones, see the instructions that are provided with the telephone.

Gather the line and extension cords hanging from the control unit and twist-tie or wire-wrap them.

Testing the modules

1. Test the base card modules by doing the following:
 - a. Plug a system telephone into the first port on each module.
 - b. Press the line button on the telephone for each outside line and listen for a dial tone.

Connecting handsets

1. For telephone systems that are based on a patch (intermediate) connection system:
2. Connect line cords to the line jacks on the modules.
3. Connect the free end of each line cord to the appropriate telephone network interface jack.
4. Fill each module before moving to the next module to the right.
5. As each handset is connected, the software it contains is automatically checked and updated if necessary.

2.5 Set the System Password

The system password is a four-digit password that users can enter from their telephones to override dialing restrictions if the extension has access to an outside line. You can set and change the system password from extensions 10 or 11.

- The password overrides all dialing restrictions.
- Once a password is programmed, you must enter it to turn Night Service on and off. Additionally, if night service is on, users in the Night Service Group must enter the password to make any outgoing calls except calls to numbers on the Emergency Phone Number List and marked system speed dial numbers.
- Dialing restrictions for extensions not in the Night Service Group remain the same as during normal daytime operation.

Set/Change System Password from an ETR 18D/34D phone

1. At a system administration extension (10 and 11); with the phone idle press Feature 0 0 followed by two presses of I ntercom 1. System Administration: is shown on the display.
2. Dial #403. The phone displays Set System Password.
3. Enter a four-digit password.
4. Exit programming by pressing Feature 00. You can also exit programming mode by lifting the handset, then place it back in the cradle.

Set/Change the system password from a 1408/1416 phone

1. At either of the system administration telephones (extensions 10 and 11), with the phone idle press Admin.
2. Use the ▲ up or down ▼ arrow buttons to scroll the display to System Administration. When displayed, press Select.
3. Use the ▲ up or down ▼ arrow buttons to scroll the display to Restrictions/Permissions. When displayed, press Select.
 - Alternatively, dial # and the same code as used by ETR phones for system administration.
4. Use the ▲ up or down ▼ arrow buttons to scroll the display to Set System Password. When displayed, press Select.
5. The current setting is displayed.
6. Enter the new four digit system password. Use Default to return to the default setting of no password.
7. Exit programming by pressing PHONE/EXIT. Alternatively use the Back button to move to another menu.

2.6 Change the Admin Password

This password controls access to the system using the IP Office Manager PC application. To change this password from a phone can only be done using extension 10 or 11.

Change remote administration password from an ETR 18D/34D phone

- At a system administration extension (10 and 11); with the phone idle press Feature 0 0 followed by two presses of Intercom 1. System Administration: is shown on the display.
- Dial #730.
- If a [system password](#) [22] has been set, the prompt Enter Sys Password: is displayed. Enter the four digit system password.
- The current password (default for new systems is Administrator) is displayed.
- Enter or change the password.
 - Enter a character by pressing the indicated button until that character is displayed. If you pause more than 1 second after press a button, the cursor will move onto the next space.

1	1!"\$%&'()+,-./	2	2abcABC	3	3defDEF
4	4ghiGHI	5	5jkIJKL	6	6mnoMNO
7	7pqrsPQRS	8	8tuvTUV	9	9wxyzWXYZ
*	*; ; < = > ? @ [\] ^ _ `	0	0Space	#	#

- To save the password, press Enter. The bottom line of the display shows the password as it has been entered.
- Exit programming by pressing Feature 00. You can also exit programming mode by lifting the handset, then place it back in the cradle.

Change remote administration password from a 1408/1416 phone

- At either of the system administration telephones (extensions 10 and 11), with the phone idle press Admin.
- Use the ▲ up or down ▼ arrow buttons to scroll the display to System Administration. When displayed, press Select.
- Dial #730.
- If a [system password](#) [22] has been set for the system, you will be prompted to enter that password before you can proceed.
- The display will show Remote password:.
 - Enter a character by pressing the indicated button until that character is displayed. If you pause more than 1 second after press a button, the cursor will move onto the next space.

1	1!"\$%&'()+,-./	2	2abcABC	3	3defDEF
4	4ghiGHI	5	5jkIJKL	6	6mnoMNO
7	7pqrsPQRS	8	8tuvTUV	9	9wxyzWXYZ
*	*; ; < = > ? @ [\] ^ _ `	0	0Space	#	#

- Use the dial pad to enter a password of up to 8 characters. When completed press Enter. To remove the characters entered so far press Clear.
- Exit programming by pressing PHONE/EXIT. Alternatively use the Back button to move to another menu.



Index

A

Administrator 23
 Analog lines 21
 Applying power 20
 Associated documents 7
 ATM4 daughter card 14

B

Base card 14
 Basic install 7
 Bulletins technical 16

C

Cable ties 16
 Cable, RJ45 12
 Card
 base 14
 combination 14
 daughter 14
 ETR 14
 front lamps 20
 SD 17, 20
 Change password 23
 Combination card 14
 Control unit
 rear 20
 CPU LED 20

D

Daughter card 14
 Dial tone 21

E

Environmental Requirements 9
 Expansion module 14
 Extensions 21

H

Hardware components 14

I

Install
 basic 7, 16
 pre requirements 16
 telephone 21
 IP500 Installation
 Card 18

L

LAN socket 20
 Laptop 7, 20
 LED CPU 20
 Lines
 analog 21
 cord 21

M

Maximum units 14

P

Part number 12
 Password
 administration 23
 changing 23
 remote access 23
 system 23
 Patch panel 21
 Power application 20
 Pre requirements 16

R

Recall 14
 Remote access 23
 Requirements
 Environmental 9
 Wall Mounting 9
 RJ45 connector 12

S

SAP code 12
 Screen
 splash 20, 23
 SD card 17
 SD card insertion 20
 SIP trunk 14
 Socket, LAN 20
 Splash screen 20, 23
 Start-up 20
 Station ports
 analog 14
 digital 14
 System
 checks 20
 telephone 21

T

Technical bulletins 16
 Telephone
 connection 16
 install 21
 stand 21
 system 21

Tie-wrap 21

Tools 16
 Trunks SIP 14

U

Unpacking 17

V

Voicemail 14

W

Wall Mounting Requirements 9

Performance figures and data quoted in this document are typical, and must be specifically confirmed in writing by Avaya before they become applicable to any particular order or contract. The company reserves the right to make alterations or amendments to the detailed specifications at its discretion. The publication of information in this document does not imply freedom from patent or other protective rights of Avaya or others.

All trademarks identified by the ® or ™ are registered trademarks or trademarks, respectively, of Avaya Inc. All other trademarks are the property of their respective owners.

This document contains proprietary information of Avaya and is not to be disclosed or used except in accordance with applicable agreements.

© 2010 Avaya Inc. All rights reserved.